



Automated two-step chromatography using an ÄKTA equipped with in-line dilution capability



Dwight Winters, Carolyn Chu, Kenneth Walker*

Therapeutic Discovery, Amgen, Inc., One Amgen Center, Thousand Oaks, CA 91320-1789, USA

ARTICLE INFO

Article history:

Received 25 September 2015

Accepted 26 October 2015

Available online 3 November 2015

Keywords:

High-throughput purification

Automated chromatography

ÄKTA

Multi-dimensional chromatography

ABSTRACT

There has been a great emphasis on developing higher-throughput protein purification techniques to screen potential human therapeutics faster and more efficiently. Not only is it desirable to have high-throughput purification for initial screens but it is also desirable to efficiently purify selected protein therapeutics in the amounts and purity required for definitive assays. Current automated tandem technologies involve size exclusion as a second step that often fails to generate the required purity, is not robust and can only be operated at a limited scale. We have modified an ÄKTA to enable in-line dilution, assuring that the automated loading of a second column from a first column elution can be modified to a pH and ionic strength which is suitable for binding to the second column. For example, Protein A can be employed as a first step followed by direct loading on to a cation exchange column by conditioning the Protein A elution using the in-line diluter. Using this method as described, up to six samples of 1 L each can be purified through two columns without human intervention per day per machine, and the system produces good yields of purified protein over a wide range of loading levels (12–300 mg). In addition, the system employs guanidine HCl regeneration, followed by a sodium hydroxide wash between purification runs, minimizing the possibility of carryover contamination. The system is described at the 5 mL and the 10 mL column sizes; however, it could readily be programmed for 100 mL columns to enable larger-scale purifications. Using this system to automate two-column purifications minimizes human intervention, increases efficiency and minimizes the risk of human error.

© 2015 Elsevier B.V. All rights reserved.

1. Introduction

There are a number of high-throughput purification techniques available for the initial screening of proteins with therapeutic potential [1,2]; however, these purification techniques are generally suitable for preliminary assays requiring relatively small amounts of purified protein. More definitive evaluations, such as *in vivo* activity assays, are often required to identify lead therapeutic candidates emerging from initial screens, and this more advanced stage of screening necessitates the purification of proteins at larger scale and greater purity. For example, antibodies purified using Protein A (Pro A) chromatography often require a polishing step to achieve the required level of purity. Ion exchange chromatography is a commonly employed step for reducing high-molecular-weight aggregates, charge variants, residual DNA, host cell protein, leached Protein A and viral particles [3]; however, the automation of medium-scale, high-purity

antibody purification remains a challenge unmet by current technologies.

Modification of the ÄKTA (GE Life Sciences, Piscataway, NJ) chromatography platform to incorporate a large format autosampler has recently been described [4]. This system automates the two steps of Protein A chromatography followed by buffer exchange chromatography; however, one limitation to this approach when using ion exchange as the second step is the necessity to adjust the pH and conductivity of the Pro A elution to enable binding to the ion exchange column. For example, binding of murine antibodies to Pro A is promoted with high pH and high salt during Pro A chromatography [5,6], and the elution from Pro A under such conditions requires dilution to enable adequate binding to the ion exchange resin. The available technologies for automated two-column chromatography, such as the ÄKTA design 3D plus Kit (GE Life Sciences, Piscataway, NJ) and the Bio-Rad NGC systems (Bio Rad, Hercules, CA), can automate the chromatographic process with two or more columns but at limited scale due to the use of buffer exchange columns for conditioning the load of the second column. Here we present a solution to this issue, by automating the inline dilution of the Pro A eluent using a low-cost static binary mixer and an additional valve to create an ÄKTA with in-line dilution capability

* Corresponding author. Tel.: +1 805 447 0520.

E-mail address: kennethw@amgen.com (K. Walker).

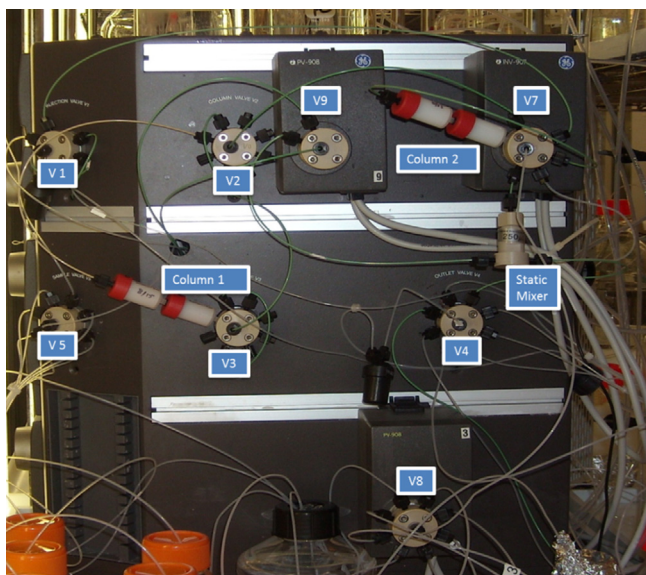

Fig. 1. The ÄKTA system is configured for two-column tandem chromatography capability with in-line dilution of the second column load. A static mixer enables the dilution of Column 1 (Pro A) eluent for loading on Column 2 (SP-HP). Valve 9 directs flow of pump A to the static mixer or to the conventional mixer. Valve 7 selects the flow to the second column. Valve 8 directs the SP-HP flow-through to separate vessels for each run. V1–V6 are standard equipment on an ÄKTA explorer.

(ILD) for direct loading to an SP Sepharose HP column (SP-HP). In-line dilution has been used to facilitate binding to a primary column [7] but not for conditioning the load of a second column in a tandem system. The ILD is capable of automating two-column purifications of up to seven samples (using the seven-sample valve lines) without human intervention, decreasing the amount of labor required to obtain highly purified protein at scales of 300 mg or greater. A conventional ÄKTA can be upgraded to a flexible ILD with minimal investment and can be adapted to automate the rapid adjustment of pH and ionic strength of a first column eluent in a variety of two-column chromatographic processes.

2. Material and methods

2.1. ÄKTA modifications

A binary static mixer was assembled using an ASI PEEK Housing (500518, Supelco, Bellefonte, PA) and a 250- μ l ASI PEEK mixer cartridge (500461, Supelco, Bellefonte, PA). The mixer was placed on an ÄKTA Explorer (GE Life Sciences, Piscataway, NJ) with one input coming from valve 4 (INV-908) line 8 (F8) and the other input from valve 9 (INV-908) line 2 (Figs. 1 and 2). Valve 9 was uniquely placed with the common line as the output of pump A. Position 1 of valve 9, the default setting, is connected to the traditional M 925 Mixer. To control the flow through the second column an INV-907 (valve 7) was used (valve 7 is often referred to as the flow direction valve). A tubing segment connected the output from the static mixer and position 4 of valve 7. Position 7 of valve 7 was connected to position 1 of valve 1, while position 1 of valve 7 was connected to the common position of valve 2. The second column was placed between position 6 and position 2 of valve 7 and position 3 of valve 7 was connected to the common position of valve 8.

2.2. Unicorn control of the Pro A, SP-HP process

The Pro A and SP-HP process, when run with 10-mL columns, utilized two-tandem 5-mL HiTrap MabSelect SuRe columns (GE Life Sciences, Piscataway, NJ) and two-tandem 5-mL Hi Trap

SP-Sepharose HP (GE Life Sciences, Piscataway, NJ) columns. When the process was run with 5-mL columns, a single HiTrap column of each was used. The media containing the antibody to be purified was brought to 25 mM tris, 0.4 M sodium citrate, pH 8.9 by the addition of 100 mM tris, 1.6 M sodium citrate, pH 9.15. The use of the Unicorn scouting method allowed for the sample valve to direct the flow from the available load vessel using the sample valve through the first column at one column volume per minute (CV/min) and into the Pro A flow-through vessel depending upon run number. When air was detected, the media remaining in the pump was loaded on the Pro A column, and then the column was bypassed and the pump and lines were flushed with 25 mM tris, 0.4 M sodium citrate, pH 8.9. The Pro A elution begins with 0.75 mL/min flow with 100% B buffer (100 mM acetic acid); then, when the UV exceeds 25 mAU, the total flow was adjusted to 10 mL/min that was 7.5% B with the flow from pump A2 (20 mM NaOAc, pH 5.0) being diverted by valve 9 for on-line dilution of the Pro A eluent directed to the static mixer through valve 4 (F8). The diluted Pro A eluent flowed through the SP-HP column and the flow through from the SP-HP was directed to the SP-HP flow through container defined by the scouting run number. The SP-HP column was then washed at 1 CV/min with 20 mM NaOAc, pH 5.0 and followed by a 30 CV gradient to 0.5 M NaCl using the up-flow command of valve 7. When the UV threshold of 25 mAU was exceeded, the eluent of the SP-HP was directed to the fraction collector (F2) with $\frac{1}{2}$ CV fractions taken. Following the gradient, the SP-HP column was stripped with 20 mM NaOAc, 1 M NaCl, pH 5.0 at 1 CV/min. The Pro A and the SP-HP were regenerated sequentially with 6 M guanidine and then sanitized sequentially with 0.2 M NaOH. The Pro A column was then re-equilibrated with 25 mM tris, 0.4 M sodium citrate, pH 8.9 and the SP-HP column was re-equilibrated with 20 mM NaOAc, pH 5.0. Following complete execution of the scouting method series, the sample lines were then flushed after manually moving the lines to a 25 mM tris, 0.4 M sodium citrate, pH 8.9 buffer and the ILD would then be ready for another scouting run series.

2.3. Capacity studies using purified human antibody

Capacity studies were performed by diluting 3, 6, 12, 25, 50, 100, 150, 200, 300 and 400 mg of purified human IgG2 antibody into 375 mL of FreeStyle F17 expression medium (Life Technologies, Grand Island, NY). The IgG2-spiked media was brought to 25 mM tris, 0.4 M sodium citrate, pH 8.9 by the addition of 125 mL of 100 mM tris, 1.6 M sodium citrate, pH 9.15. The ILD Pro A and SP-HP Unicorn method (supplemental) was then run using flow rates and buffer systems as previously described using 10 mL HiTrap Pro A and SP-HP columns. The in-line dilution of the Pro A pool was also evaluated with an 8-fold dilution. The Pro A column was eluted at 1.25 mL/minute with 100 mM acetic acid and when the absorbance of at 280 nm exceeded 25 mAU, the eluent was diluted with 20 mM sodium acetate, pH 5.0 at 8.75 mL/min. To calculate yield, the fractions were pooled and the amount of antibody recovered was compared to the amount added into the load. To convert absorbance to protein concentration, the following formula was used ($1 \text{ mg/mL} = 1.436 \text{ OD at } 280 \text{ nm}$). Absorbance was determined by analyzing 2 μ l of sample on a Nanodrop spectrophotometer (Thermo Scientific, Wilmington, DE), and the pool volumes were measured in appropriately sized graduated cylinders.

2.4. Resolution studies using aggregate containing human antibody

To study the resolution of the SP-HP step when placed in tandem with the Pro A column using the ILD, a partially purified

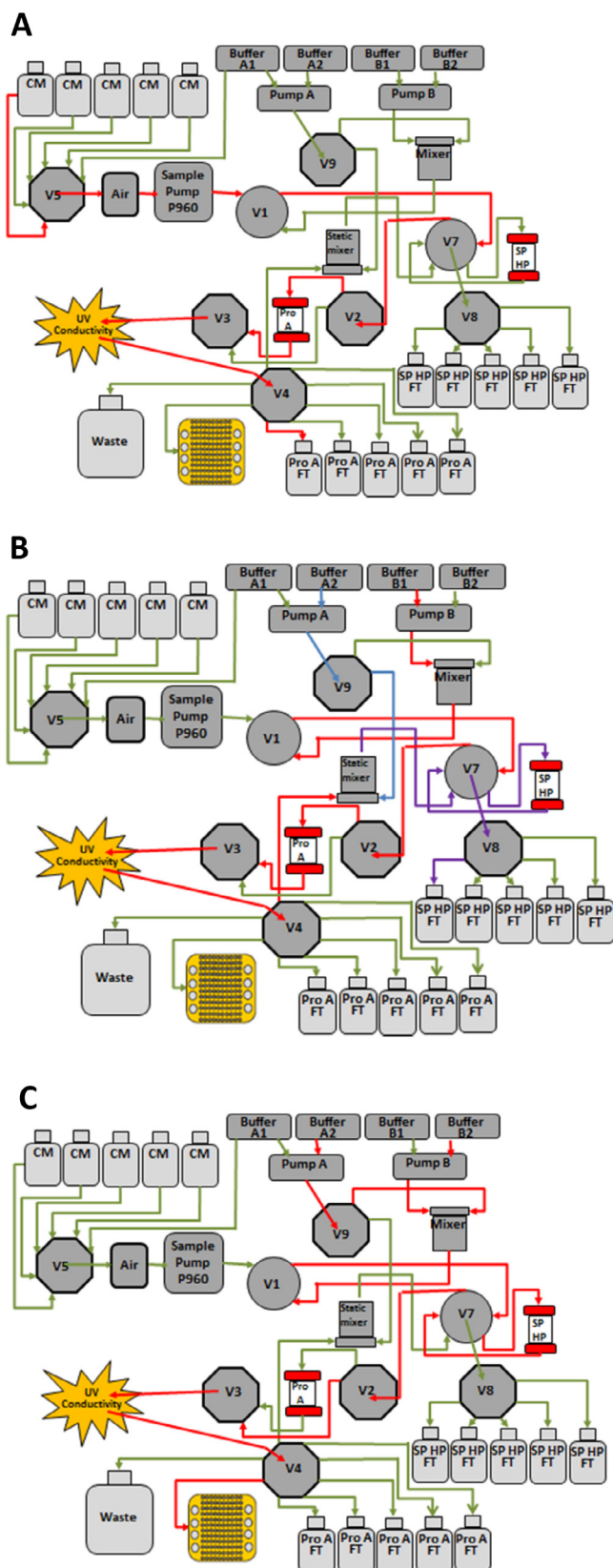

Fig. 2. Flow schematic for tandem system. This includes a sample pump and an air sensor which are located inside the ÄKTA Explorer cabinet. There are two seven-port valves indicated by a circle and six eight-port valves indicated by an octagon shape. (A) The flow for the loading of the MabSelect SuRe step is indicated by the red arrows, and the flow-through for the Pro A is collected in a separate vessel for each run. (B) The flow diagram for the elution of the Pro A column and simultaneous loading of the SP-Sepharose HP column. The flow of the Pro A elution buffer is indicated by the

recombinant human antibody containing aggregate was used. The antibody was obtained from a cation exchange fraction that contained a 10.5% aggregate peak as determined by analytical SEC. The analytical SEC was performed using Zenix-C SEC-300 column (7.8 mm diameter, 300 mm length, Sepax Technologies, Newark DE) with a running buffer of 50 mM sodium phosphate, 0.25 M NaCl, pH 6.9 at a flow rate of 1 mL/min. The fraction was formulated in 10 mM sodium acetate, 9% sucrose, pH 5.0 buffer at 85.7 mg/mL and stored in aliquots at -80°C . To evaluate the resolution of aggregate by SP-HP when processed using the ILD, 25, 100 or 200 mg of the antibody was diluted into 375 mL of FreeStyle F17 expression medium (Life Technologies, Grand Island, NY). The media was brought to 25 mM tris, 0.4 M sodium citrate, pH 8.9 by the addition of 125 mL of 100 mM tris, 1.6 M sodium citrate, pH 9.15, and the prepared samples were then purified in tandem using the ILD Pro A and SP-HP method using 10 mL columns as previously described. To convert absorbance to protein concentration for the fractions, the following formula was used ($1 \text{ mg/mL} = 1.436 \text{ OD at } 280 \text{ nm}$), and the absorbance was determined by analyzing $2 \mu\text{l}$ of sample on a Nanodrop spectrophotometer (Thermo Scientific, Wilmington, DE). The aggregate level of each fraction was determined by analytical SEC as previously described. To compare the tandem system with a direct SP-HP separation, a 100-mg aliquot was diluted into 200 mL of 20 mM sodium acetate, pH 5.0 and loaded directly on a 10 mL (two 5 mL HiTrap columns) SP-HP column. The SP-HP column was washed with 20 mM sodium acetate, pH 5.0 and then eluted in a 30 CV gradient to 0.5 M NaCl, pH 5.0 at 10 mL/min matching the SP HP elution parameters of the tandem system. When the absorbance at 280 nm exceeded 25 mAU, 5 mL fractions were taken and evaluated in the same manner as the tandem fractions.

2.5. Purification of murine antibodies

Conditioned media from five murine hybridomas, ranging from 0.15 to 1.5 L were purified using the ILD with 5 or 10 mL columns as previously described. Fractions were pooled based on analytical SEC (as previously described) and SDS-PAGE. SDS-PAGE was carried out using 4–20% tris-glycine gels (Invitrogen, Grand Island, NY) and stained with QuickBlue (BostonBiologicals, Boston, MA). The pools were evaluated for concentration using Nanodrop spectrophotometer (Thermo Scientific, Wilmington, DE), and the purity of the final product was determined by analytical SEC and SDS-PAGE.

3. Results

In order to enable direct loading of a first-column (Pro A) eluent to a second column (SP-HP), in-line eluent conditioning was automated using an ÄKTA Explorer by equipping it with an in-line static mixer to create an ILD system (Fig. 1). In addition to the static mixer, a PV-908 valve (V9) was installed with the common port attached directly to the output of pump A. The default setting of this valve (V9.1) directs the pump A flow to the traditional mixer, M-925, while the V9.2 setting diverts flow to the static mixer. An optional PV-908 valve (V8) was used to partition the bulk SP-HP flow-through fractions from the different samples, and an air

red arrows while the flow of SP-HP buffer A and dilution buffer is indicated by the blue arrows. When absorbance is detected by the UV monitor the flow is diverted to the static mixer where the Pro A elution is combined with a dilution buffer. The diluted Pro A eluent is indicated by the purple arrows. (C) The flow pattern for the elution of SP-HP column is indicated by red arrows. The flow path is directed from the UV monitor to the fraction collector utilizing the same flow path as used for conventional chromatography (For interpretation of the references to color in this figure legend, the reader is referred to the web version of this article.).

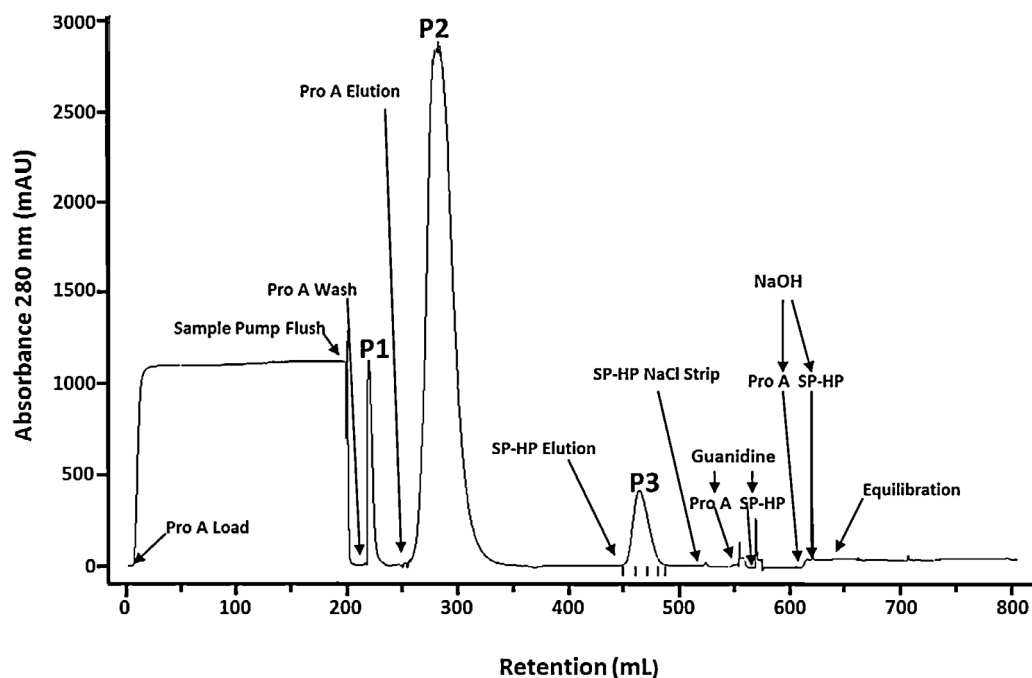

Fig. 3. Representative chromatogram of a typical murine hybridoma antibody purification using the ILD tandem Pro A/SP-HP system. P1 is the Pro A column wash of the weakly bound material found in the load. The P2 is the Pro A elution peak which is artificially elongated, as only 7.5% of the flow is through the UV monitor while the AKTA plots the chromatogram for 100% of the flow. P3 is the elution peak of the SP-HP column.

sensor (Air 912N) was added prior to the sample pump to detect the end of the load and trigger the next chromatographic step.

The flow paths for the Pro A load, elution of the Pro A column with simultaneous loading and elution of the SP-HP column are shown in Fig. 2. The loading of the Pro A column began with the conditioned media (CM), designated by sample valve (V5) and directed by V7 to bypass the SP-HP column (Fig. 2A). The CM then passed through the Pro A column, and the outlet valve (V4) directed the flow to the appropriate Pro A collection vessel to collect the unbound material. The Pro A elution buffer B was then delivered by pump B, and when the UV exceeded the user-selected threshold, a series of valve changes directed the Pro A elution to the static mixer where it was in-line diluted with SP-HP equilibration buffer that had been directed by V9 (Fig. 2B). The flow was then directed towards the SP-HP column by V7, and the SP-HP flow-through was sent to the appropriate container by V8. To elute the SP-HP column, a standard gradient was formed (with the A and B pumps) using buffers A2 and B2 and V7 directed the flow through the SP-HP column first, then to V2 and V3 which bypassed the Pro A column. The flow for the elution was directed to the UV detector where the user-defined UV threshold peak detection sends proteins eluted from the SP-HP column to the fraction collector.

A murine hybridoma antibody was purified using the ILD system with a 5-mL MabSelect SuRe (Pro A) as column 1 and a 5-mL SP Sepharose HP as column 2 (Fig. 3). To promote binding to the Pro A column, the conditioned media was combined with 100 mM tris, 1.6 M sodium citrate, pH 9.15 to condition the load to a final buffer consisting of 25 mM tris, 0.4 M sodium citrate, pH 8.9. The diluted CM was then loaded on the Pro A column until air was detected. The sample pump was then flushed with buffer A1, and the residual load material and air was pushed through the system with buffer A1 bypassing the Pro A column to rinse and re-prime the pump for subsequent loads. The Pro A column was then washed with buffer A1 (25 mM tris, 0.4 M sodium citrate, pH 8.9), producing P1, followed by elution with 100 mM acetic acid, producing P2. The Pro A elution peak broadening is an artifact of the unique flow pattern of the ILD, which was caused by only 7.5% (0.75/10) of the total flow

being directed to the static mixer bypassing the UV detector; thus, the integrated area for the Pro A peak must be adjusted by a factor of 0.75/10 to obtain the corrected area in mAu/mL. The mixed flow from the in-line diluter was the Pro A elution diluted 1:13 (0.75/10) with A2 buffer (20 mM sodium acetate, pH 5.0), which reduces the ionic strength and enables binding to the SP-HP column. The flow through of the SP-HP column was not monitored and was therefore not captured on the chromatogram, as the ILD does not have the capability to monitor more than one flow stream at a time. The SP-HP column was then washed with 20 mM sodium acetate, pH 5.0, with the flow directed to the monitor followed by elution with a sodium chloride gradient producing P3. A peak fractionation command was used to collect the fractions, thus conserving the number of tubes used by diverting flow to waste when no absorbance is detected. Following gradient elution of the SP-HP column, a high-salt buffer was employed to elute tightly bound contaminants and the Pro A and SP-HP columns were then regenerated by first applying a guanidine HCl buffer sequentially to the Pro A and the SP-HP columns followed by a NaOH buffer producing a series of small peaks. The Pro A and SP-HP columns were then equilibrated with the appropriate buffer so that both columns were ready for subsequent runs in the queue.

To demonstrate the effective range of the ILD system using 10 mL columns, 3–400 mg of antibody was purified using the two-column process (Pro A and SP-HP) (Fig. 4). Samples were prepared by adding 3–400 mg of purified human antibody to 375 mL of F-17 media which was then brought to 25 mM tris, 0.4 M citrate, pH 8.9. The amount of in-line dilution was tested at two levels to determine the impact of dilution on yield. An 8-fold dilution was evaluated, as this amount of dilution has been shown to promote full antibody binding of a pooled Pro A elution to an SP-HP column when the high-salt method is used (data not shown). A 13-fold dilution was also evaluated, as the dilution requirement at the start of a Pro A peak will be greater than the dilution requirement of the pool due to carryover ionic strength from the Pro A wash buffer. The yield was calculated by comparing protein recovery with the amount loaded, which was consistent at 87–92% for a 12 mg to 150 mg challenge

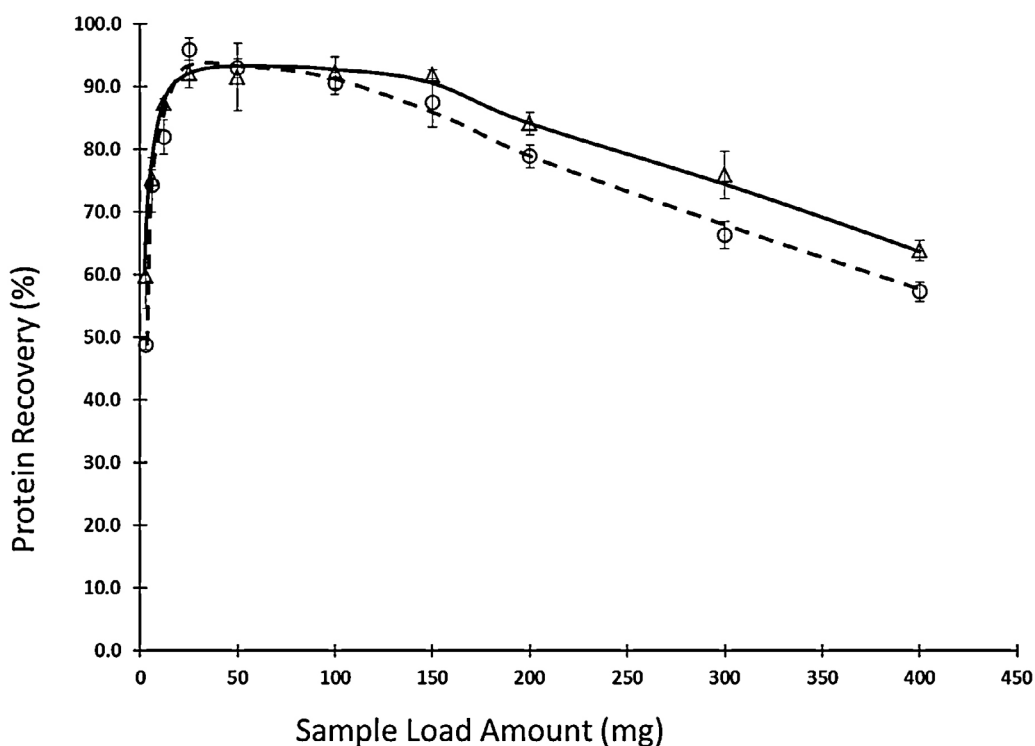

Fig. 4. Total capacity of the ÄKTA tandem system. Protein loads between 3 and 400 mg of human IgG2 antibody were tested on tandem system using 10 mL Pro A and SP-HP columns. The elutions of the Protein A were in-line diluted at both 8-fold (circles) and 13-fold (triangles) before loading on the SP-HP column. The values shown are averages of three independent experiments, and the error bars are the standard error of the mean.

using a 13-fold inline dilution, and it was comparable to using an 8-fold dilution with a yield of 82–96% under the same conditions (Fig. 4). At the lower 3–6 mg load levels, the 13-fold dilution provided moderately higher yields of 60–75% compared to 49–74% for the 8-fold dilution. At the 200, 300 and 400 mg load levels, the yields for the 13-fold dilution were also modestly higher (86, 72 and 63%) then for the 8-fold dilution (79, 66 and 57%).

The impact on the resolution of the 10 mL SP-HP column when placed in the tandem system was evaluated by comparing resolution of aggregates using the 10 mL SP-HP column alone and in tandem with the Pro A column. A Pro A purified antibody containing relatively high levels of aggregate was used for this assessment at a 100-mg challenge. Resolution of aggregates from the main peak was equivalent between the directly loaded SP-HP and that of the tandem Pro A to SP-HP with the aggregate undetectable in the early fractions of the peak and subsequently aggregate levels increasing to 34% across both peak profiles (Fig. 5). The effect of protein loading levels on the resolution of the SP-HP column was also evaluated by loading 25, 100 and 200 mg of the aggregate containing IgG2 antibody onto the ÄKTA-ILD with 10 mL Pro A and SP-HP columns. Partial resolution of the antibody aggregate was equivalent for all three levels of challenge (Fig. 6), and the initial fractions contain no aggregate, with the aggregate levels increasing to 32–33% across the peaks at all load levels.

In order to test the robustness of the system, five murine hybridoma antibodies in conditioned media that varied from 150 to 1400 mL were purified using the ÄKTA-ILD, and the resulting SDS-PAGE analysis of the major fractions from a representative purification are presented in Fig. 7A. The antibodies bound to both the Pro A and the SP-HP columns as evidenced by the lack of the antibody in the flow-through fractions of both columns, and as expected, the Pro A column did not bind the protein contaminants found in the conditioned media, as the amount and intensity of the contaminant bands in the Pro A load lane match with that observed in the Pro A flow-through lane. High molecular weight contaminants were then resolved from the main band on the SP-HP column and were only observed in the final fraction as evidenced by the protein band in the well of lane 12 of the gel. The resulting SDS-PAGE of the five final products was typical of antibodies produced from hybridoma media using two separate steps, with a single band observed when run under non-reduced (Fig. 7B) and heavy- and light-chain bands when run under reducing conditions (Fig. 7C). The purity achieved with the tandem system was sufficient to fully characterize the antibodies and for *in vivo* activity assessment. The load volumes, column size and yields of the five antibodies are shown on Table 1. The peak areas (300 nm) of the Pro A peak was determined and compared to the peak area of the pooled SP-HP peak at 300 nm (Table 1). The area of the Pro A

Table 1
Data summary of murine hybridoma antibodies purified using the tandem ÄKTA-ILD system.

Hybridoma	Column (mL)	Load (mL)	Yield (mg)	Main peak SEC (%)	Pro-A 300 nm area (mAu/mL) ^a	SP-HP 300 nm pooled area (mAu/mL)
1	5	150	7.8	95.3	468	443
2	5	150	17.5	98.9	1029	877
3	10	1400	130	97.6	5334	5692
4	10	550	52.9	98.3	2440	2278
5	10	1400	198	98.1	9234	10,254

^a The area is adjusted to reflect the actual flow rate through the detector.

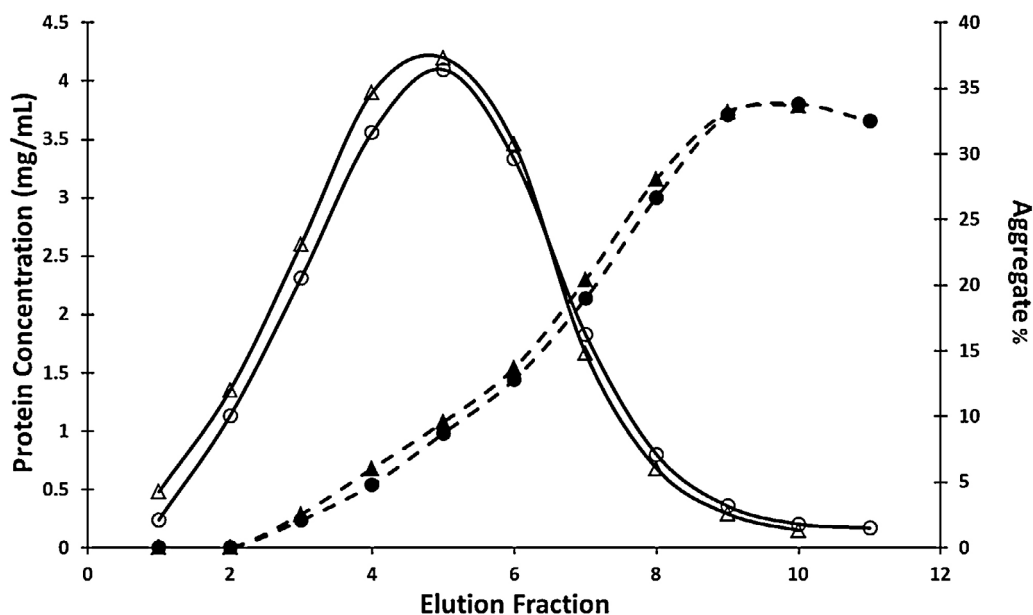

Fig. 5. An antibody containing aggregate (100 mg) was used to determine the impact on resolution of the SP-HP column when placed in tandem with a Pro A column. The resolution of this aggregate on the 10-mL SP-HP column when used in the tandem system (circles) was compared to the resolution when directly loaded on a 10-mL SP-HP column (triangles). The protein concentration of the elution fractions are open triangles for the directly loaded SP-HP and open circles for the tandem SP-HP column. The percentage of aggregate in the elution fractions, as determined by analytical SEC using Zenix-C SEC-300, are shown as filled triangles for the directly loaded SP-HP columns and filled circles for the tandem Pro A to SP-HP columns.

peak was adjusted to account for the flow that bypassed the detector and diluted the Pro A elution post UV detector. The adjusted Pro A peak area and the area of the SP-HP peak are similar for the five purifications indicating that there is little loss between the two automated steps. There is also good correlation between

the SP-HP peak area and the yield of the pools independently determined by UV measurement indicating that the pools were made without error. The analytical SEC purity, which was above 95% for the five pools, is also shown on Table 1, as this is a critical quality parameter.

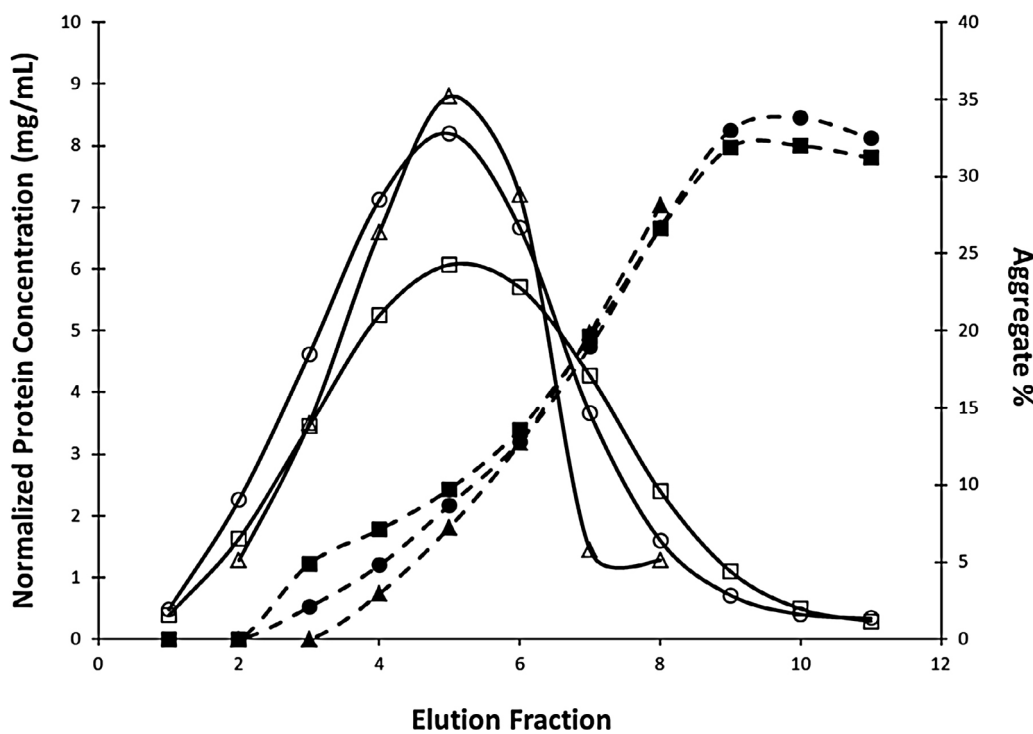

Fig. 6. The resolution of aggregate is evaluated at three different levels of sample loading for the tandem Pro A to SP-HP system. The SP-HP elution fractions of a 10-mL tandem system loaded with 25 mg of aggregate containing human IgG2 antibody (triangles), 100 mg of antibody (circles) and 200 mg of antibody (squares). The open triangles, circles and squares indicate normalized protein concentration of the SP-HP fractions. The solid symbols indicate the percent aggregates of the fractions as determined by analytical SEC using Zenix-C SEC-300. The protein concentrations of fractions for the 25 mg challenge were increased by a factor of eight, while the fractions from the 100 mg challenge were increased by a factor of two so as to normalize with that of the 200 mg challenge.

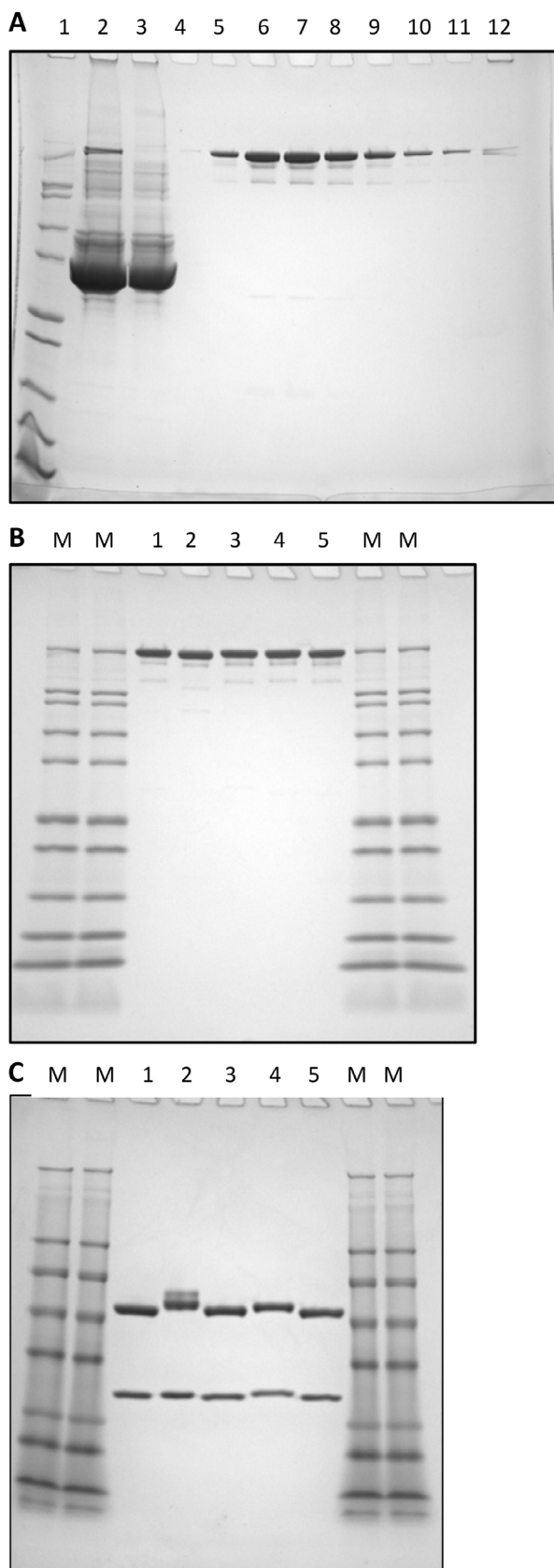

Fig. 7. Coomassie-stained SDS-PAGE of murine hybridoma purification process. (A) The SDS-PAGE of fractions of a representative murine hybridoma purification using the ILD system. Lane 1 is the Novex Mark 12 molecular weight standard, lane 2 murine hybridoma media conditioned used for Pro A loading, lane 3 is the Pro A column flow-through and lane 4 is the flow-through collected for the SP-HP column. The elution fractions for the SP-HP are lanes 5–12. SDS-PAGE of five hybridoma

4. Discussion

Lately, there is considerable focus on increasing purification throughput in support of screening large panels (100–300) of engineered protein molecules. Often, initial screening requires only a small amount of protein for preliminary evaluation of expression levels, simple stability and *in vitro* activity. Our laboratory has met this need by integrating a large format autosampler (LFAS) with the ÄKTA chromatography system, which is capable of automating affinity purification and formulation of 65 samples (10 mL) per day per instrument [4]. However, there is often a need to purify larger amounts of protein with purity requirements only achievable through a second chromatographic modality. Much of the instrumentation available, such as the ÄKTA design 3D plus Kit, which automates two chromatographic steps, relies on sample loops and holding tubes for transient storage of the intermediate elution peaks which limits the scale of tandem chromatography. The ILD employs a direct loading of the second column with the eluent of the first column eliminating the need for transient storage and saving processing time by combining the first column elution and the second column loading steps. Without additional modification, the tandem chromatography systems cannot accommodate direct loading to a second chromatographic step if the material eluted from the first column will not bind the second column without alteration of the pH and/or ionic strength. Instrumentation is available that automates the conditioning of a first column eluent for binding to a second column. For example, the ÄKTA Pure (GE Life Sciences, Piscataway, NJ), NGC system or the BioLogic DuoFlow (Bio Rad, Hercules, CA) employ a buffer exchange column to condition the affinity elution for loading on to a polishing column [8–10]. Although these systems offer the flexibility of directly loading the protein to the polishing column in tandem, they require the complication of an intermediated buffer exchange (desalting) column to condition the first column eluent to promote binding to the polishing column. The ILD system is unique in that it adjusts both pH and ionic strength of the first column eluent stream “in line,” thus allowing protein binding on to the second column. In contrast to other systems, the ILD employs a continuous feed stream, which renders it amenable to any scale purification and it eliminates the buffer exchange column that requires additional cleaning between cycles. In addition, the use of dilution employed by the ILD system for conditioning the polishing column loading is less likely to exceed maximum protein solubility than the use of a buffer exchange column in which pH and ionic strength changes occur with minimal dilution, thus reducing the risk of inducing protein aggregation.

The ILD system, as described, can purify up to five samples without intervention. The system also captures individual bulk flow-through fractions for both columns, allowing for mass balance determination and sample recovery in the case of an unexpected failure to bind the resins; however, the system can purify up to seven samples if the individual flow-through fractions are not recovered. Furthermore, with an autosampler added to the ÄKTA (4), the number of samples that could be run unattended would be limited only by the capacity of the fraction collector. The described ILD is a modified ÄKTA Explorer or ÄKTA Purifier; however, the newer model ÄKTA Pure and other chromatographic systems, such as the BioRad NGC with sufficient valves, an added static mixer and flexible programming, could be adapted to provide the same capabilities as the ILD using the methods described herein.

antibodies purified using the ILD. The antibodies were run on gels using non-reducing conditions (B) and reducing conditions (C). The lanes marked by M are the See Blue molecular weight markers. The numbered lanes are the purified hybridoma antibodies also listed on Table 1.

Protein carry over from one chromatographic run to the next is a major concern when conducting purifications sequentially. This risk is particularly acute when automating pH and molarity shifts during processing with molecules of unknown solubility properties, since they can unexpectedly precipitate. To address this issue, the ILD regenerates and sanitizes the columns and system with guanidine HCl and sodium hydroxide solutions. The existing systems using a buffer exchange column for pH and ionic strength changes, with minimal dilution, would be more likely to exceed solubility limits and would be a greater challenge to regenerate between runs. Preparative size exclusion columns used in tandem are particularly susceptible to precipitation events as well and they take prohibitively long to regenerate and equilibrate when guanidine HCl and NaOH cleaning methods are used between chromatographic runs.

While the initial screening of proteins can often be done with relatively small amounts of protein (less than 1 mg), more in-depth testing often requires up to 100 mg or greater amounts of protein for characterization and activity studies. This demand can be met with the ILD as demonstrated by the high yield of the antibodies using tandem Pro A and SP-HP columns in the range of 12–200 mg load challenges on 10 mL columns. Since this system is fully scalable, any decrease in yield due to heavy column loading could be addressed by increasing the size of the columns. Furthermore, the 13-fold dilution method produced a yield that was 75% or greater for the extended range of 6–300 mg protein load, and the 13-fold dilution only marginally impacts the throughput, adding approximately 6 min per run. Since tandem purification of a 1000-mL load requires about 4 h to complete, the number of purifications at the 1000 mL scale that can be completed with a single ILD in 1 day is six whether using 8-fold or 13-fold dilutions.

The purity obtained from the ILD is equivalent to that achieved with conventional non-tandem purification across a wide range of protein load challenges. This was demonstrated by the resolution of challenging aggregates, which gave comparable results when chromatographed directly on SP-HP or when processed by the ILD system with SP-HP tandem to the Pro A. Therefore, the differences in binding conditions between these methods had little or no impact on the resolution of the aggregates observed across the two elution peaks. The resolution of the aggregate was also found to be similar when the ILD system was loaded with 25, 100 and 200 mg of antibody containing the challenging aggregates; thus, this single configuration is able to produce similar results for a panel of proteins having a wide range of titers.

Since some proteins lack stability in the often harsh affinity column elution buffer, limiting the time of exposures to these buffers would be of benefit to the yield and purity during purification [11].

As described, the tandem column in-line dilution system limits the exposure to the acidic conditions encountered during Pro A elution as the pH of the eluent was raised from three to five less than 1 min post elution. In addition, due to the flexibility of this system, most two-column purification strategies can be accommodated. Alternatively, with minor modification to the plumbing of the ILD, the flexibility of this system allows for the conditioned column one eluent to be collected without loading on to a second column. This allows for post column conditioning to protect the eluted protein even when direct loading to a second column is not desired.

The ILD improves protein purification throughput and limits exposure to potentially destabilizing conditions with only a modest increase in investment by automating two column purifications through elimination of the need for manual pooling of the first column and subsequent conditioning. This automation also increases instrument utilization efficiency by eliminating the downtime caused by runs that require pooling and conditioning between steps that occur during non-working hours. In addition, the possibility of human error during the fraction pooling, conditioning and reloading on the second column are eliminated by the use of the ILD. The ILD is a flexible and more efficient way to purify proteins in large quantities, when the purification requirements cannot be met with single-column purification, and it is a novel approach that increases the throughput for the purification of high-quality proteins in quantities large enough to perform definitive characterization and activity studies.

Appendix A. Supplementary data

Supplementary data associated with this article can be found, in the online version, at <http://dx.doi.org/10.1016/j.chroma.2015.10.092>.

References

- [1] J. Koehn, I. Hunt, *Methods Mol. Biol.* 498 (2009) 1.
- [2] A. Tworak, J. Podkowinski, M. Figlerowicz, *BioTechnologia* 92 (2) (2011) 119.
- [3] H.F. Liu, J. Ma, C. Winter, R. Bayer, *mAbs* 2 (5) (2010) 480.
- [4] D. Yoo, J. Provchy, C. Park, K. Walker, *J. Chromatogr. A* 1344 (2014) 23.
- [5] G. Schuler, M. Reinacher, *J. Chromatogr.* (1991) 61.
- [6] R. Lindmark, K. Thoren-Tolling, J. Sjequist, *J. Immunol. Methods* 62 (1983) 1.
- [7] U. Neue, C. Mazza, J. Cavanaugh, Z. Lu, T. Wheat, *Chromatographia* 57 (2003) 121 (Suppl.).
- [8] Y. Kim, I. Dementieva, M. Zhou, R. Wu, L. Lezondra, P. Quartey, G. Joachimiak, O. Korolev, H. Li, A. Joachimiak, *J. Struct. Funct. Genom.* 5 (2004) 111.
- [9] J. Sigrell, P. Eklund, M. Galin, L. Hedkvist, P. Liljedahl, C. Markeland-Johansson, T. Pless, K. Torstenson, *J. Struct. Funct. Genom.* 4 (2003) 109.
- [10] S. Taylor, M. Mguyen, F. Mavandadi, W. Liu, *Bioradiat. Tech. Bull.* (2009) 5926.
- [11] A. Shukla, P. Gupta, X. Han, *J. Chromatogr. A* 1171 (2007) 22.